

Customer Portal - myOerlikon.com



Customer portal myOerlikon.com

The new customer portal myOerlikon.com

myOerlikon.com is the customer portal
providing the service of tomorrow for the
customers of today

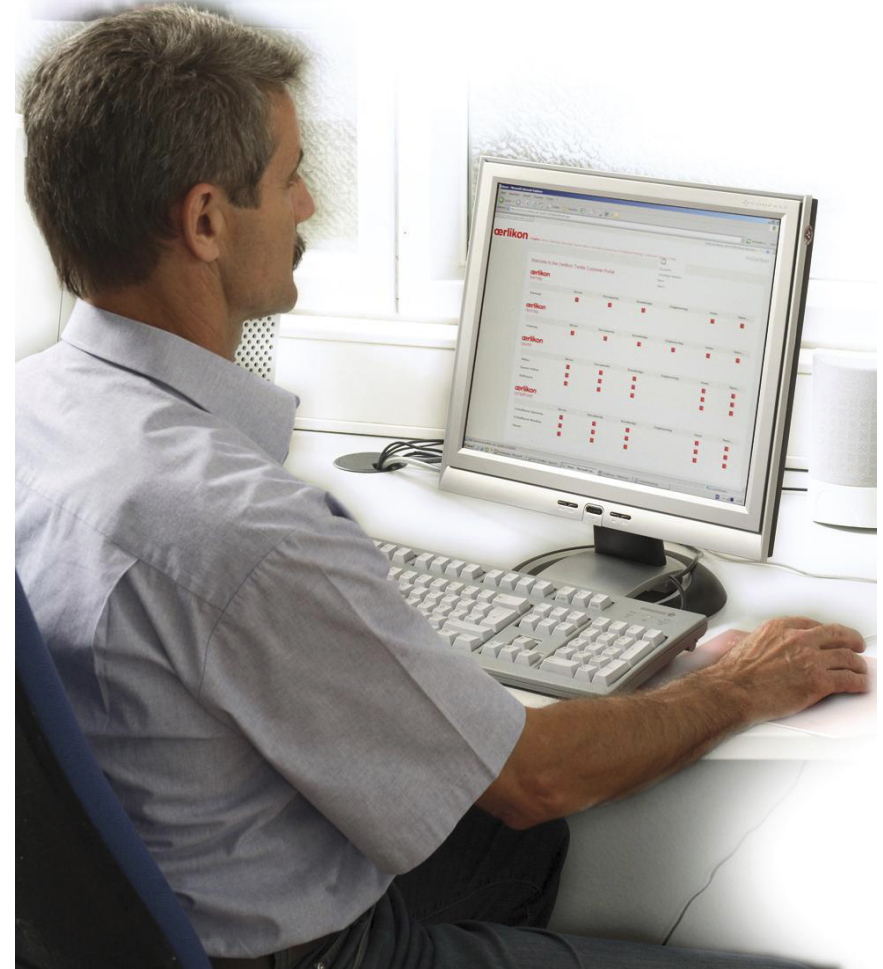

Customer portal myOerlikon.com

Into the service future with just a click

- myOerlikon.com is for all our customers
- Access to the communication of the future and to a new world full of possibilities
- One click and the whole world of services becomes available

oerlikon
barmag

oerlikon
neumag

oerlikon
saurer

oerlikon
schlafhorst

Customer portal myOerlikon.com

Modules for inexhaustible information

- SECOS
- Documents
- Knowledge
- Engineering
- More

Everything a company needs – users benefit

Welcome to the Oerlikon Textile Customer Portal

oerlikon
barmag

	Secos	Documents
Barmag		

oerlikon
neumag

	Secos	Documents
Neumag		

oerlikon
saurer

	Secos	Documents
Allma		
Saurer Arbon		
Volkman		

oerlikon
schlafhorst

	Secos	Documents
Open End Spinning		
Winding Ring Spinning		

Customer portal myOerlikon.com

SECOS

The e-commerce system popular all over the world

- Thousands of customers benefit from the advantages of Secos right around the clock

- All you need to do:
 - Switch on the computer
 - Log in
 - Select desired spare parts
 - Enter delivery information
 - The order is already being processed

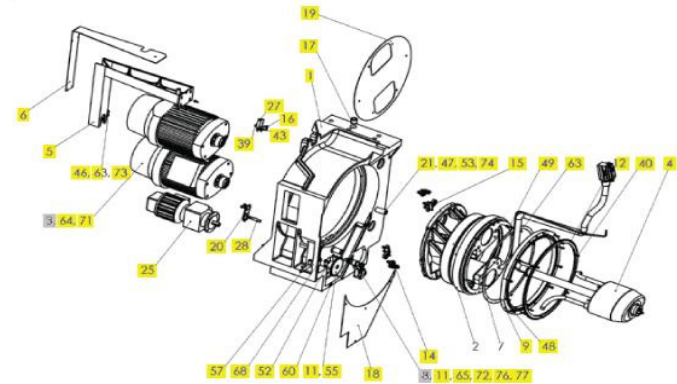

ch | SECOS

Catalog no.	Stock	Price
	3597	1.92
22	5014	0.10
	3597	1.92
9	22483	0.04
7	1732	0.23
052002	3597	1.92
	On request	On request

Customer portal myOerlikon.com

Documents

The “online administration” of tomorrow

- Each customer receives access to his/her individual machine documentation and service manuals

- Advantages:
 - Always the latest information
 - Easy, intelligent searching
 - Easily legible and straightforward
 - No more filing cabinets and printouts

- Individual and always up-to-date

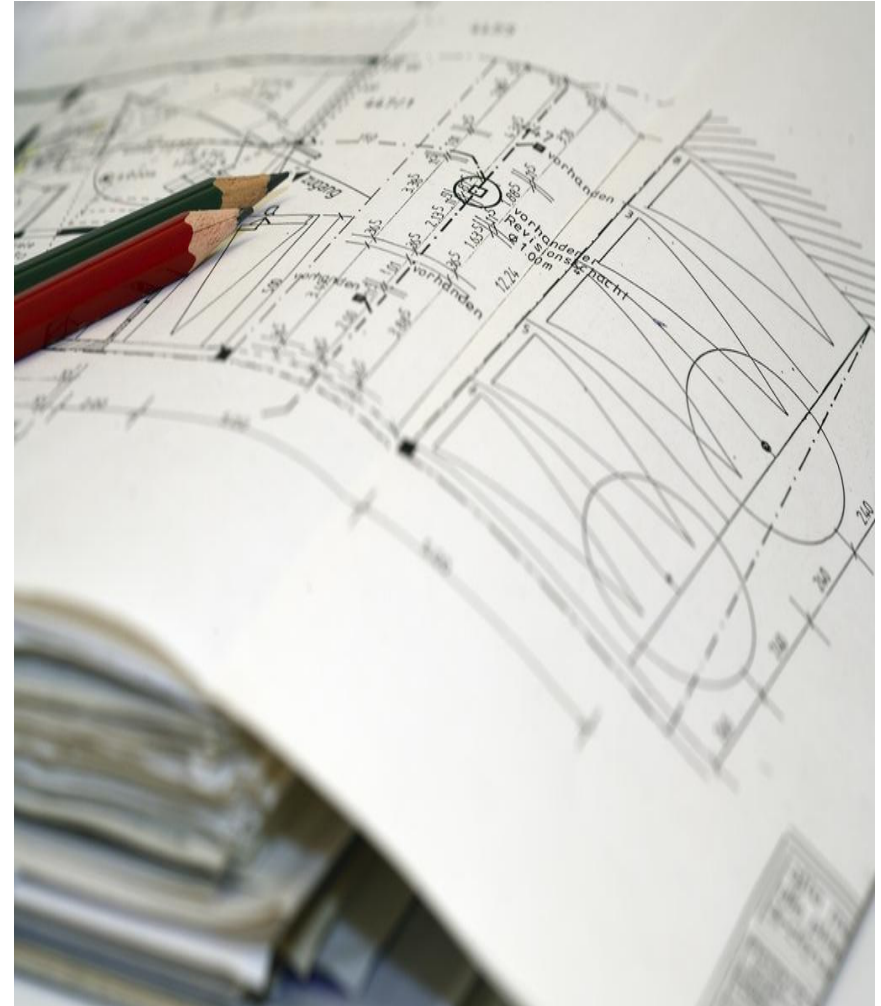

Customer portal myOerlikon.com

Knowledge

Knowledge knows no limits

- Our customers have access to the latest techniques and technologies
 - tests
 - analyses
 - all aspects of production
 - FAQ's

- The knowledge database is constantly being further developed

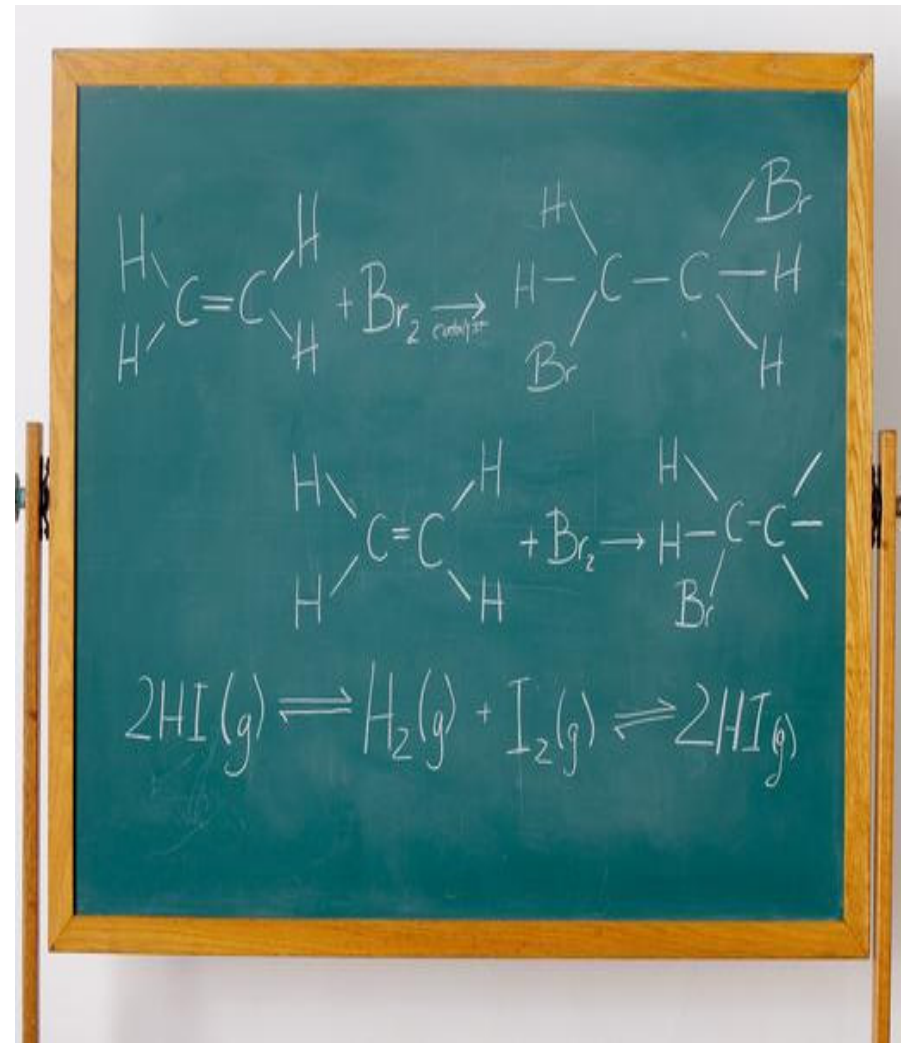

Customer portal myOerlikon.com

Engineering

The process tool from A to Z

- All documents and information are available at any time, from the concept to the turnkey plant
 - the entire project management
 - machine deliveries
 - commissioning
 - guarantees and quality aspects



Customer portal myOerlikon.com

More

New individual solutions for individual brands

- We are developing new ways and possibilities in order to be able to help you even faster and even more specifically
- Functions such as ticketing, e-learning etc. are progressive and efficient tools which we test and make available to you



FANCY FORUM

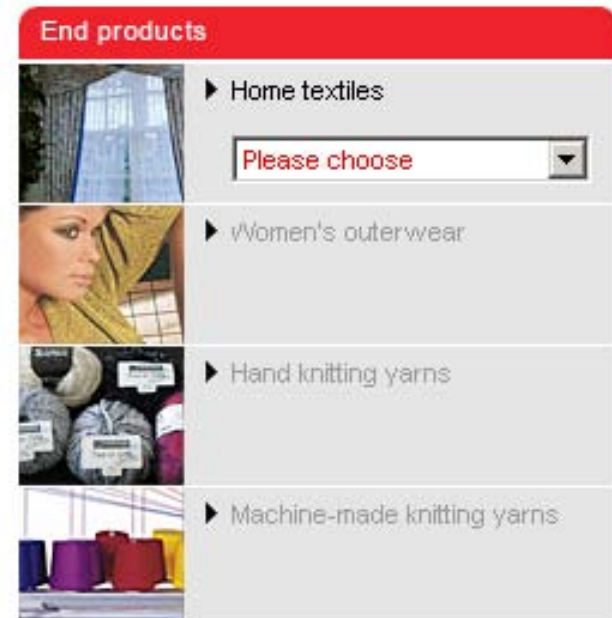

Customer portal myOerlikon.com

Security included

- Do not worry about unauthorised accessing

- We guarantee
 - state-of-the-art security standards
 - complete data protection using the most secure codes
 - working together with the most competent software supplier in the world

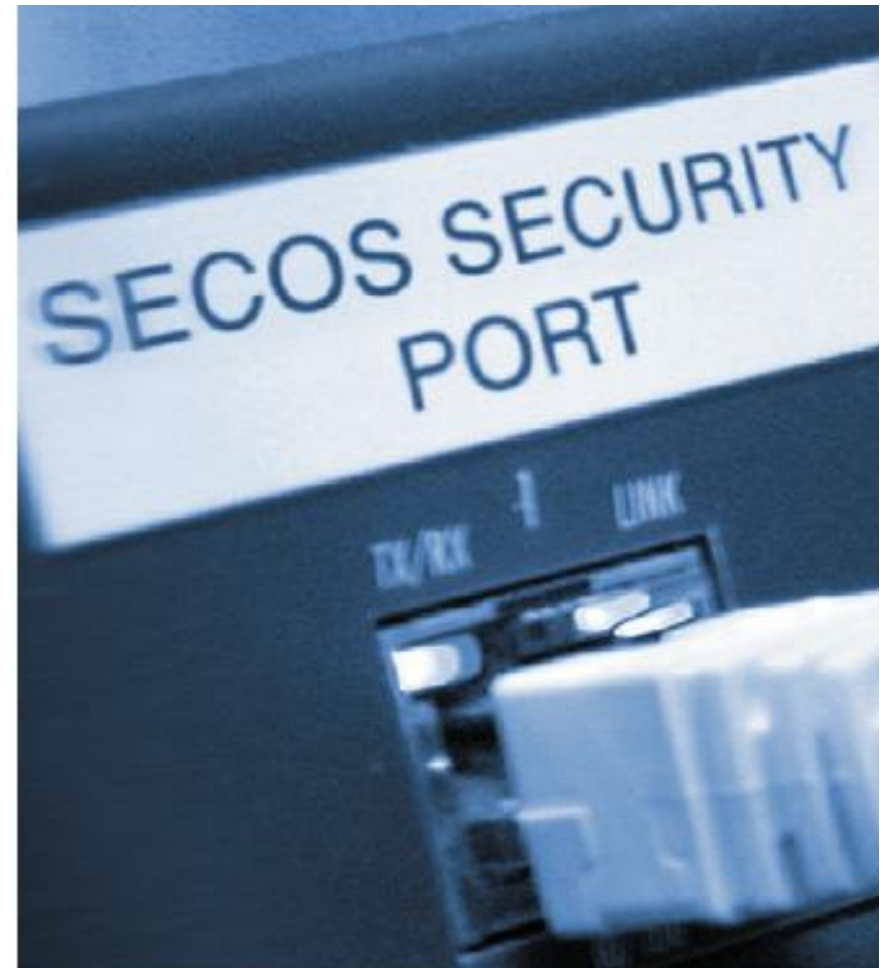

Customer portal myOerlikon.com

Users benefit

- With greater plant availability and productivity

- Result
 - definite cost reduction
 - efficient access times
 - optimal processes
 - 24 x 7 x 365

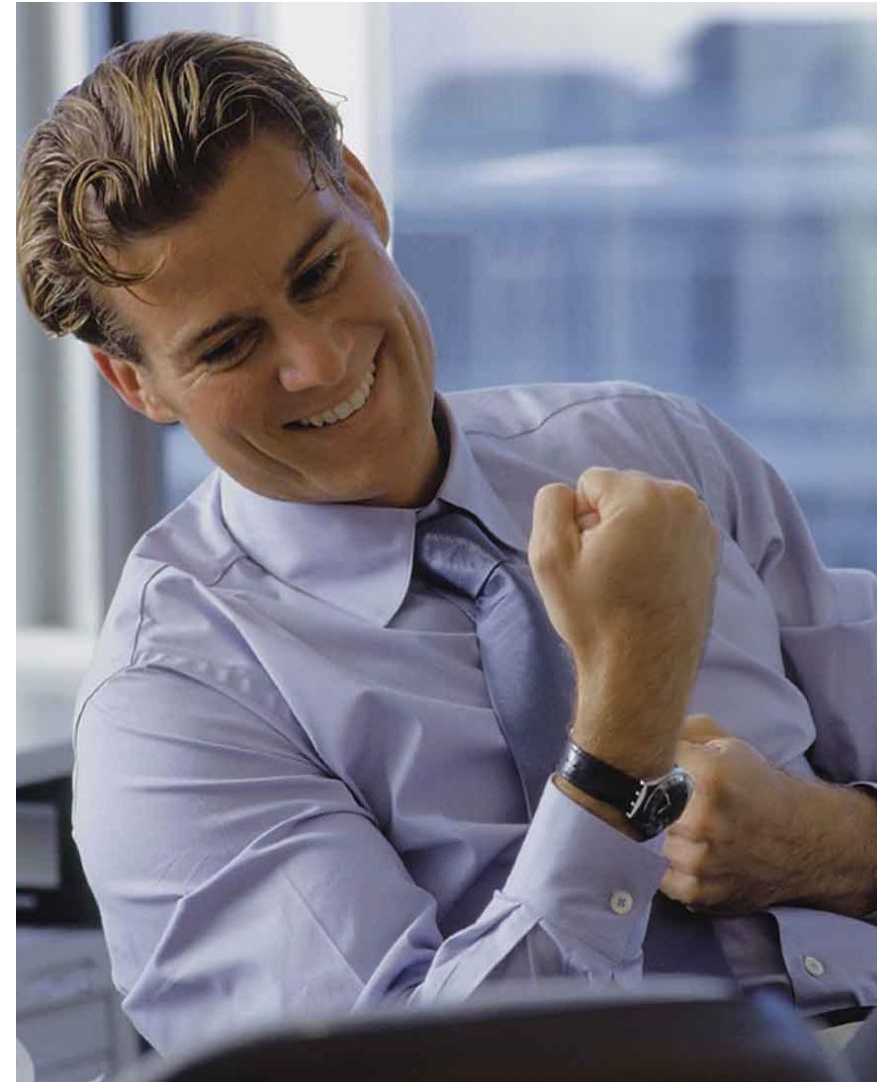

Customer portal myOerlikon.com

Welcome

- Come and visit us –it’s so easy
 - Switch on your computer
 - Enter www.myOerlikon.com

- Look at the information

- Fill in the registration form

-and you are ready to start

